

# Memory Module Specifications

## KF564C32BWEA-32

32GB 4G x 64-Bit

DDR5-6400 CL32 288-Pin DIMM

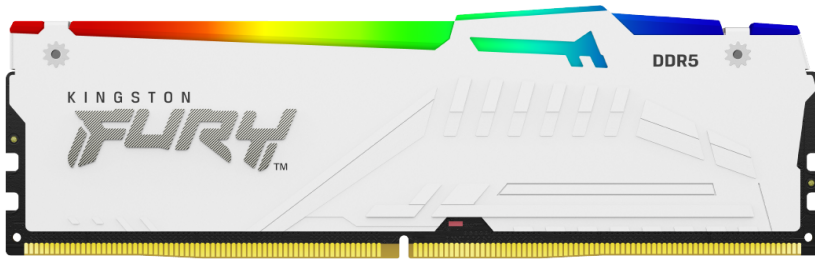

### DEFAULT SPECIFICATIONS

|  |                   |
|--|-------------------|
| CL(IDD)  | 40 cycles         |
| Row Cycle Time (tRCmin)                          | 48ns(min.)        |
| Refresh to Active/Refresh Command Time (tRFCmin) | 295ns(min.)       |
| Row Active Time (tRASmin)                        | 32ns(min.)        |
| UL Rating  | 94 V - 0          |
| Operating Temperature                            | 0° C to +85° C    |
| Storage Temperature                              | -55° C to +100° C |

### DESCRIPTION

Kingston FURY KF564C32BWEA-32 is a 4G x 64-bit (32GB) DDR5-6400 CL32 SDRAM (Synchronous DRAM) 2Rx8, memory module, based on sixteen 2G x 8-bit FBGA components per module. The module supports AMD® EXPO v1.1 and Intel® Extreme Memory Profiles (Intel® XMP) 3.0. Each module has been tested to run at DDR5-6400 at a low latency timing of 32-39-39 at 1.4V. The SPDs are programmed to JEDEC standard latency DDR5-4800 timing of 40-39-39 at 1.1V. Each 288-pin DIMM uses gold contact fingers. The JEDEC standard electrical and mechanical specifications are as follows:

### DEFAULT FEATURES

- Power Supply: VDD = 1.1V Typical
- VDDQ = 1.1V Typical
- VPP = 1.8V Typical
- VDDSPD = 1.8V to 2.0V
- On-Die ECC
- Height 1.66" (42.23mm), w/heatsink

### FACTORY TIMING PARAMETERS

- Default (JEDEC): DDR5-4800 CL40-39-39 @1.1V
- EXPO Profile #0: DDR5-6400 CL32-39-39 @1.4V
- EXPO Profile #1: DDR5-6000 CL30-36-36 @1.4V
- XMP Profile #1: DDR5-6400 CL32-39-39 @1.4V
- XMP Profile #2: DDR5-6000 CL30-36-36 @1.4V

Continued >>

### MODULE WITH HEAT SPREADER

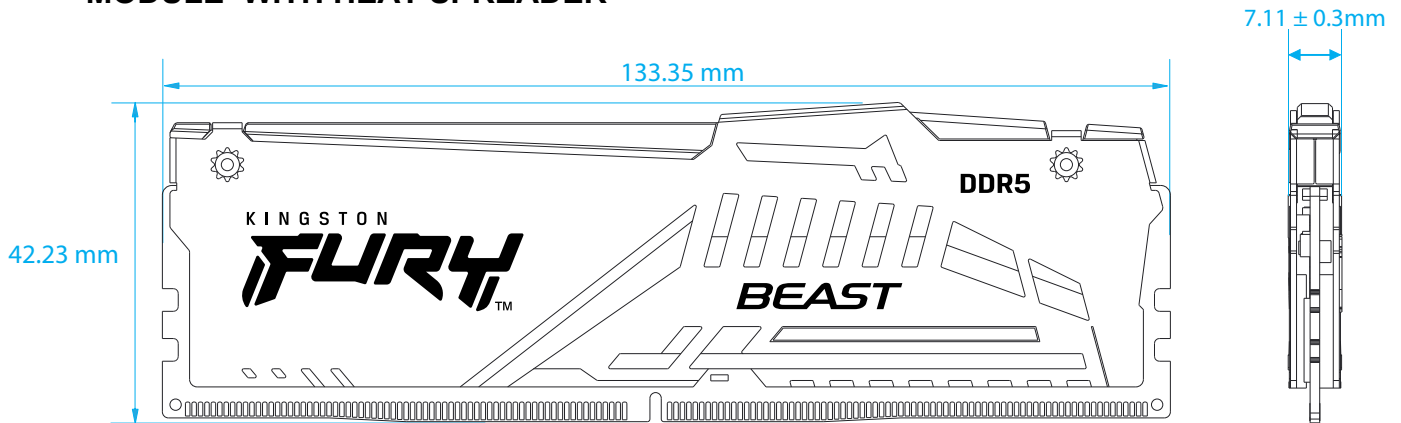

### MODULE DIMENSIONS

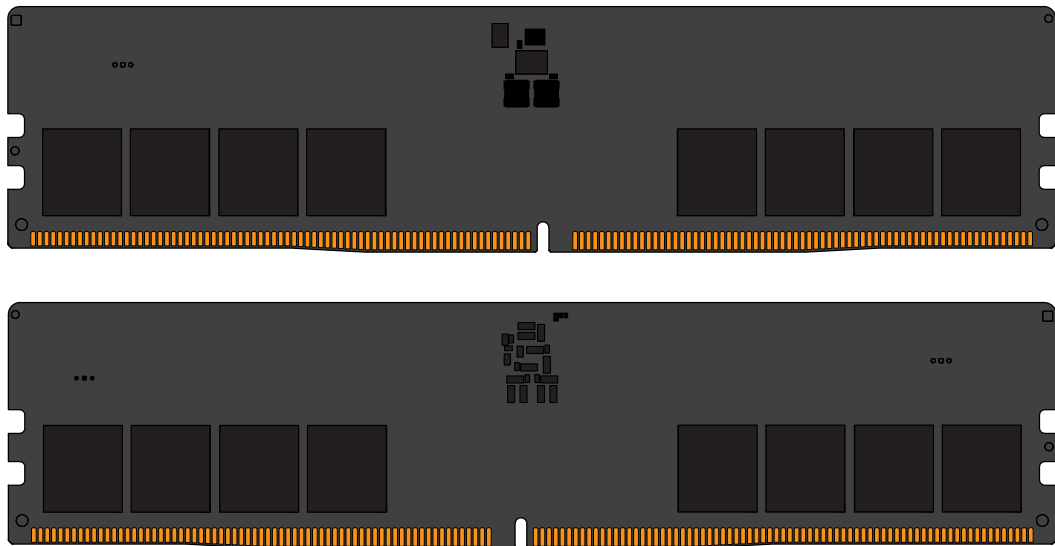

All measurements are in millimeters.  
(Tolerances on all dimensions are  $\pm 0.15$  unless otherwise specified)

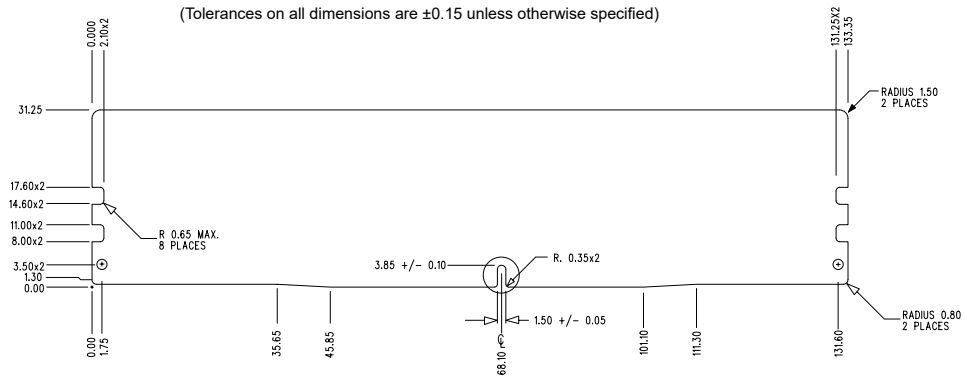

The product images shown are for illustration purposes only and may not be an exact representation of the product. Kingston reserves the right to change any information at anytime without notice.

FOR MORE INFORMATION, GO TO [KINGSTON.COM](http://KINGSTON.COM)

All Kingston products are tested to meet our published specifications. Some motherboards or system configurations may not operate at the published Kingston FURY memory speeds and timing settings. Kingston does not recommend that any user attempt to run their computers faster than the published speed. Overclocking or modifying your system timing may result in damage to computer components.

| Revision No.  | History         | Release Date | Remark | Editor   | Approved |
|---|-----------------|--------------|--------|----------|----------|
| A   | Initial Release | 02/27/24     |        | David Y. | Alex S.  |
| <p>*Products and specifications discussed herein are for evaluation and reference purposes only and are subject to change without notice. All information discussed herein is provided on an “as is” basis, without warranties of any kind.</p> |                 |              |        |          |          |